

# AstroDev Helium Radios

## PRODUCT OVERVIEW

### OVERVIEW

The Helium radio product line provides a CubeSat Kit-compatible communication system for extreme environment applications. Helium radios feature variable frequency selection and variable output power. They are compatible with standard amateur radio ground stations capable of communication at 1200 bps, 9600 bps, or higher bit rates using GMSK modulation.

The Helium 100 series radios (He-100) are mode B transceivers; they transmit on the 440 MHz amateur radio band and receive on the 140 MHz amateur radio band. Custom frequencies are available per customer requirements.

The Helium 100 series radios are available as a PC104-size board, compatible with the Cubesat Kit Bus standard developed by Pumpkin, Inc.

A digital command and data interface is provided to the radios. Through this interface the radio is configured, data is received, and data is sent for transmission. A packet protocol with checksums is implemented between the host and radio for robust access.

The radios communicate using a subset of the AX.25 packet protocol or a user specified binary protocol. In AX.25, only unnumbered information (UI) frames are supported. The packet source and destination call signs are configurable. The radios can pass through the binary data without any processing, allowing users to define custom protocols and forward error correction.

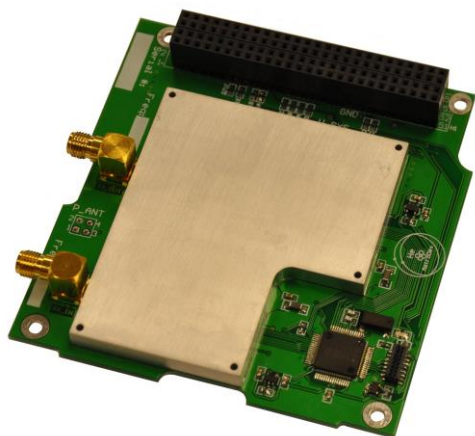

Figure 1-- He-100 radio

### Applications:

- Cubesat Kit systems
- High altitude balloon missions
- Rovers or other remotely operated vehicles
- Remote embedded systems

### Features:

- FSK/GMSK transceiver
- Frequencies:
  - TX: 120 – 150 MHz or 400-450 MHz
  - RX: 400 – 450 MHz or 120-150 MHz
- Receive sensitivity: -104.7 dBm @ BER 10<sup>-3</sup>
- Output transmit power: 100 mW – 7 W
- Input voltages:
  - Logic: 3.3V
  - Transmitter 5-13V
- Power usage:
  - Receive: < 200 mW <sup>1</sup>
  - Transmit: < 16 W <sup>1</sup>
- Maximum data rate: 38.4 kbps (higher speeds under test)
- Full duplex
- Protocol support:
  - Subset of AX.25
  - User defined through a transparent byte-level interface.
- Serial interface: 3.3V UART
- Form factor (CubeSat Kit compatible):
  - Stand alone board
- Operating Temperature: -30 to +70 °C

### Options:

- AES 128 or 256 Encryption
- For more information, contact:  
info@astrodev.com



He-100 emits RF radiation that may interfere with the use of other devices. Users must maintain proper licenses during operation.



He-100 is static sensitive, take the necessary precautions



He-100 requires proper termination of transmitter in 50 Ohm load during operation.

<sup>1</sup> Full ready state for transmission and reception. Lower power receive and transmit modes are user configurable.

**Table of Contents**

ABSOLUTE MINIMUM AND MAXIMUM RATINGS .....3  
PHYSICAL CHARACTERISTICS .....3  
TYPICAL PERFORMANCE CHARACTERISTICS .....4  
RADIO CONNECTION INFORMATION .....7  
    System Block Diagram .....7  
    CSK Interface Header Description .....7  
COMMUNICATING WITH THE LITHIUM RADIO .....8  
RADIO CONFIGURATION PROGRAM .....8  
DIMENSIONS AND FORM FACTOR .....8  
PROTECTING AGAINST ELECTROSTATIC DISCHARGE .....9  
TRADEMARKS .....10  
DISCLAIMER .....10  
NOTES .....10

## ABSOLUTE MINIMUM AND MAXIMUM RATINGS

Parameter	Symbol	Min.	Nom.	Max.	Units
Operating temperature	T <sub>OP</sub>	-30.0 to +70.0			°C
<i>Interface Voltages and Currents:</i>					
Voltage on Battery Pin (CSK Bus)	V <sub>batt</sub>	5.0		12.0	V
Current on Battery Pin	I <sub>bat</sub>	0.1		1.5	A
Voltage on System Pin (CSK Bus)	V <sub>sys</sub>	3.0	3.3	3.6	V
Current on System Pin	I <sub>sys</sub>		0.10		A
Voltage on UART Pins (CSK Bus)	V <sub>uart</sub>	3.0	3.3	3.6	V
Voltage on Reset Pin (CSK Bus)	V <sub>reset</sub>	3.0	3.3	3.6	V

## PHYSICAL CHARACTERISTICS

Parameter	Notes	Symbol	Min.	Typ.	Max.	Units
Mass				78		G
Maximum Height above PCB			0.0	6.35	11.64	Mm
Maximum Height below PCB			0.0	2.50	2.54	Mm
PCB Width <sup>1</sup>				90.00	90.17	Mm
PCB Length <sup>1</sup>				95.25	96.0	mm
PCB Thickness			1.58	1.60	1.63	mm

---

<sup>1</sup> CSK Standard Board

**TYPICAL PERFORMANCE CHARACTERISTICS**

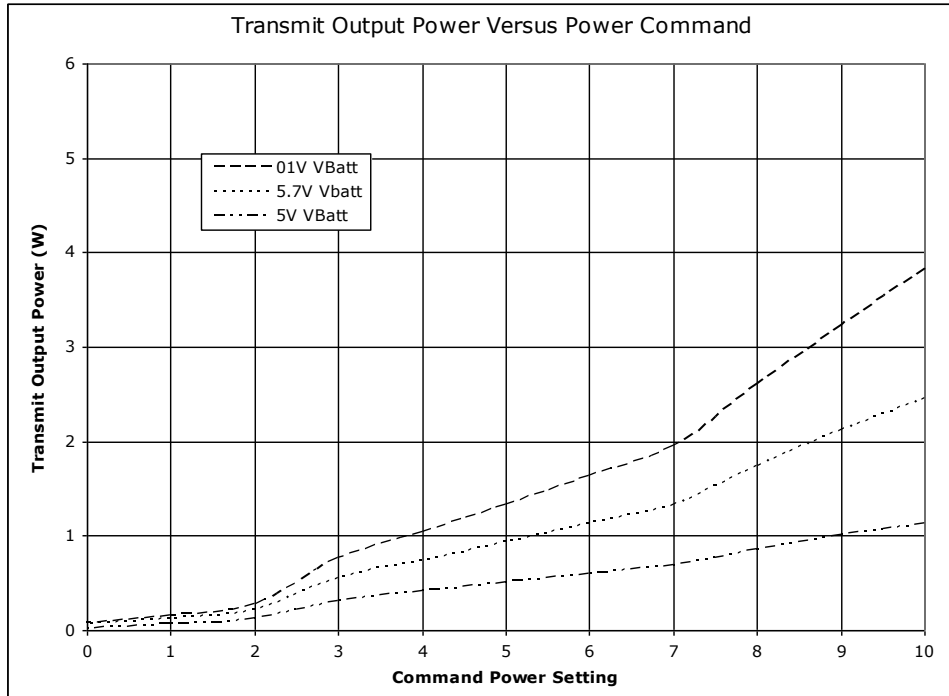

Figure 2 – Output Power vs. Power Setting.<sup>2</sup>

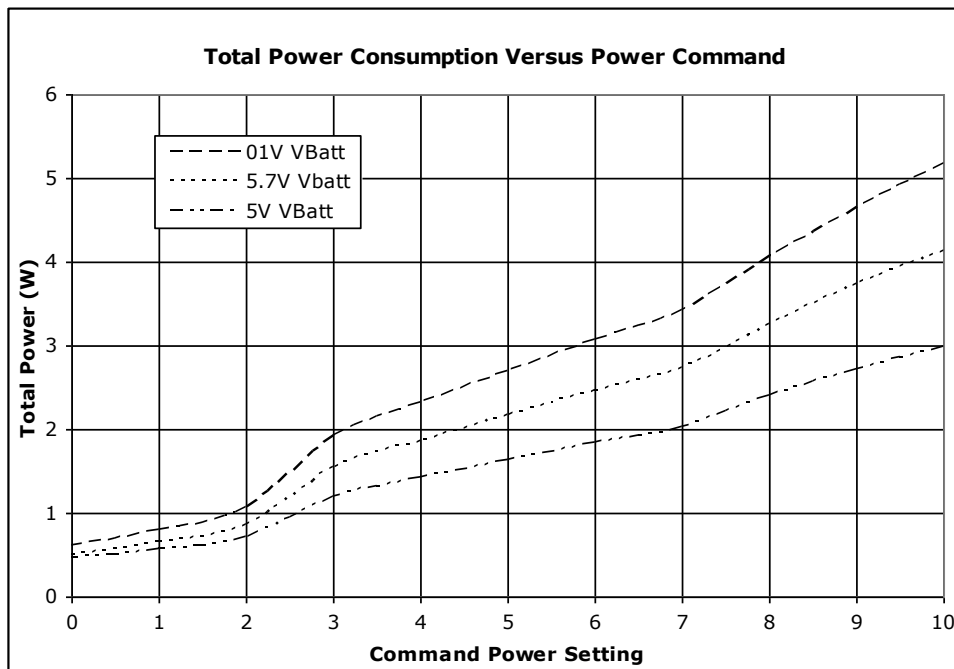

Figure 3 -- Power Consumption vs. Power Setting.<sup>2</sup>

<sup>2</sup> Representative, individual units will vary due to customer options.

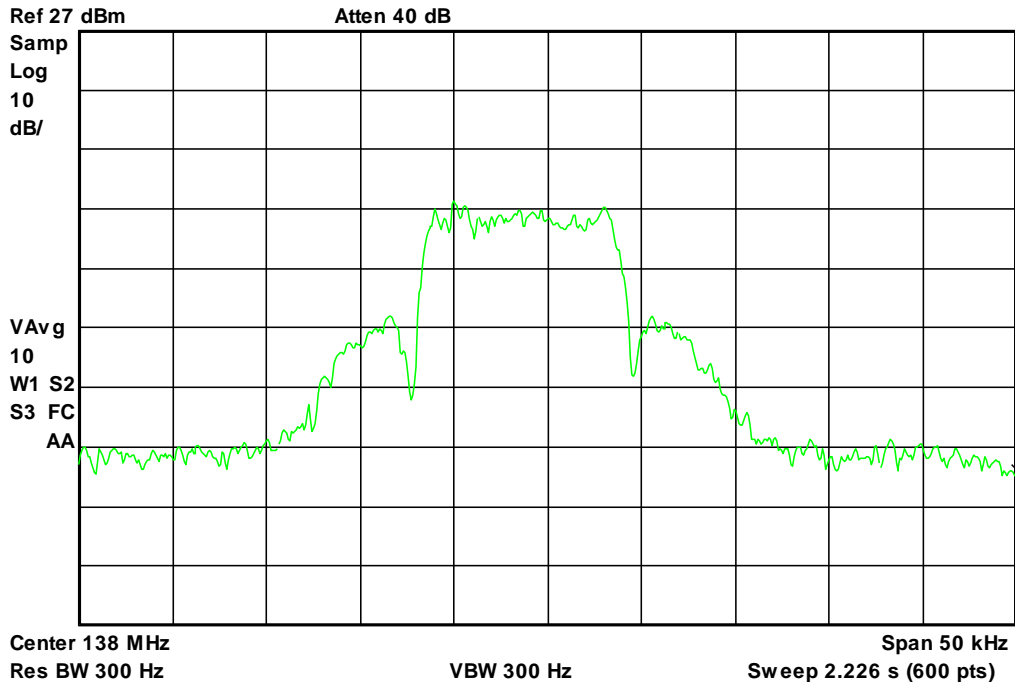

Figure 4 – He-100 GFSK 9600 Baud Output Spectrum.<sup>3</sup>

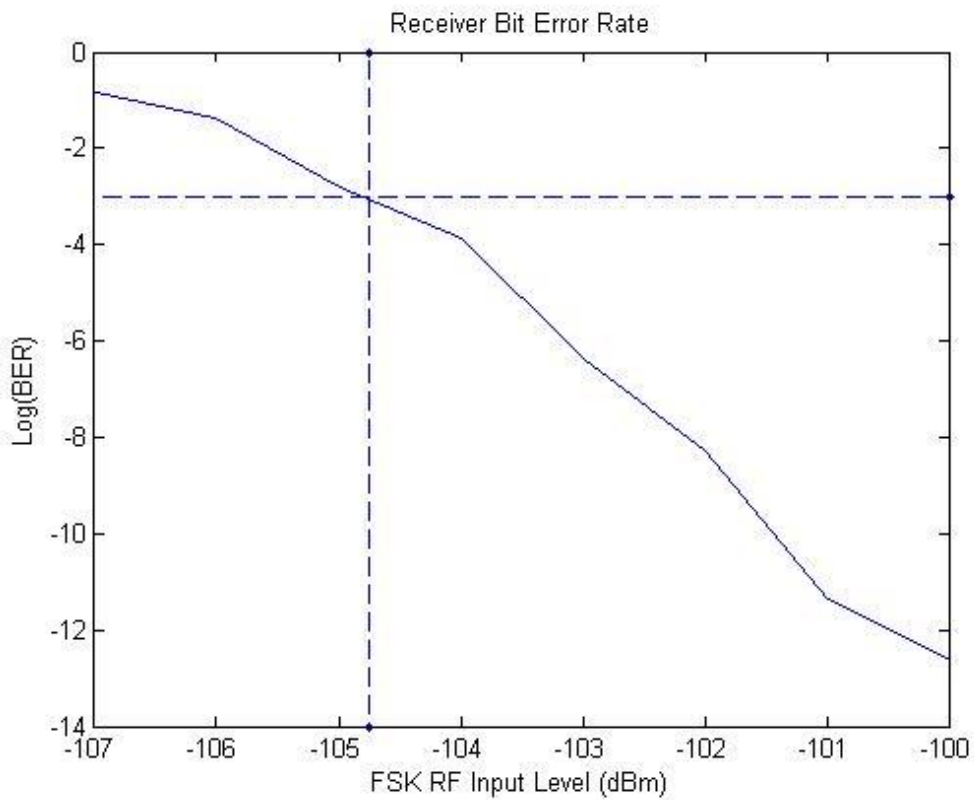

Figure 5 – Receive mode BER vs. Input Power<sup>3</sup>

<sup>3</sup> Representative, individual units will vary due to customer options.

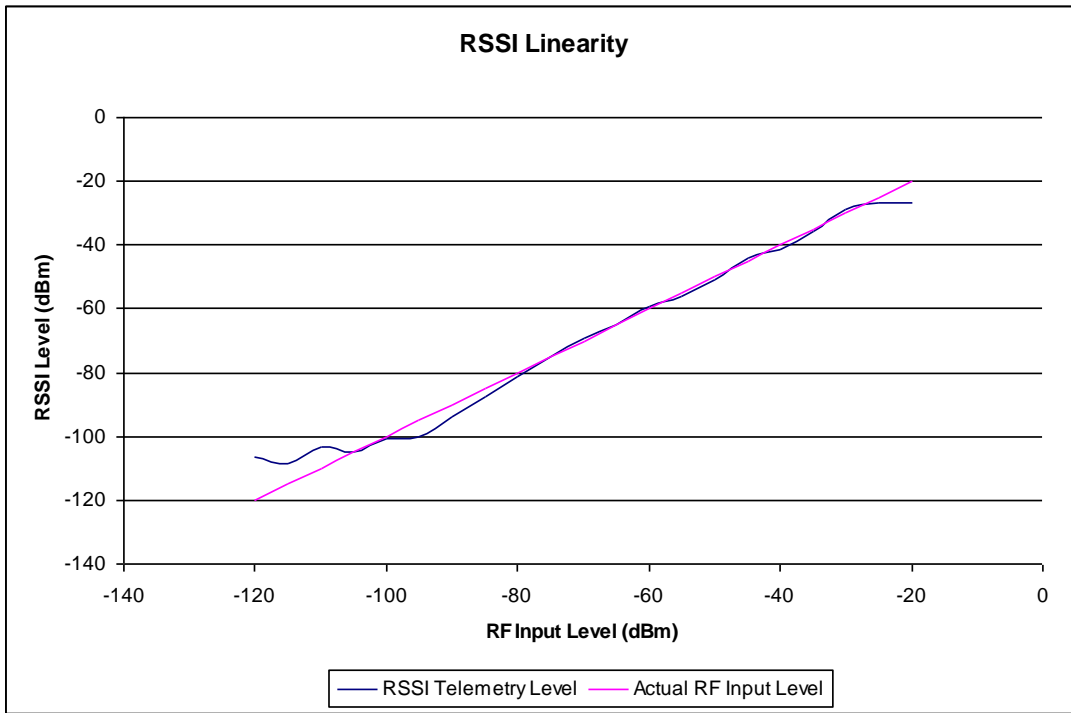

Figure 6 -- RSSI Linearity. <sup>4</sup>

<sup>4</sup> Representative, individual units will vary due to customer options.

# RADIO CONNECTION INFORMATION

## System Block Diagram

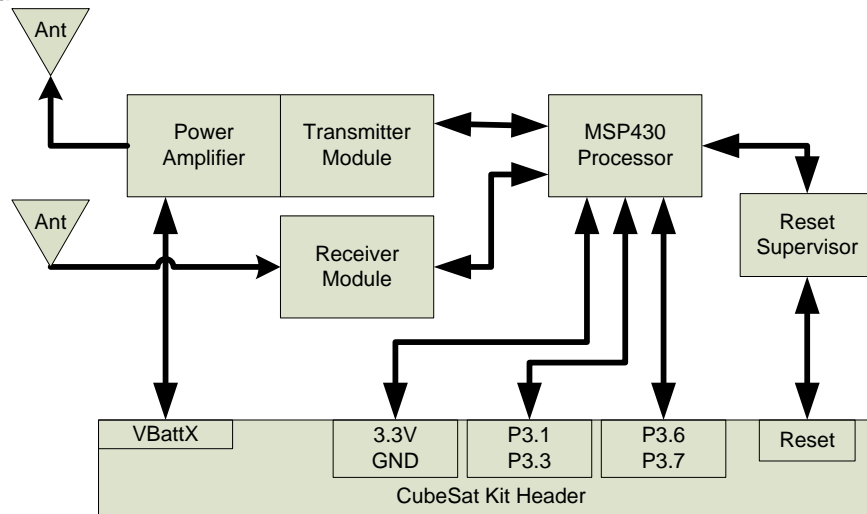

Figure 7--System block diagram of the Helium Radios.

## CSK Interface Header Description

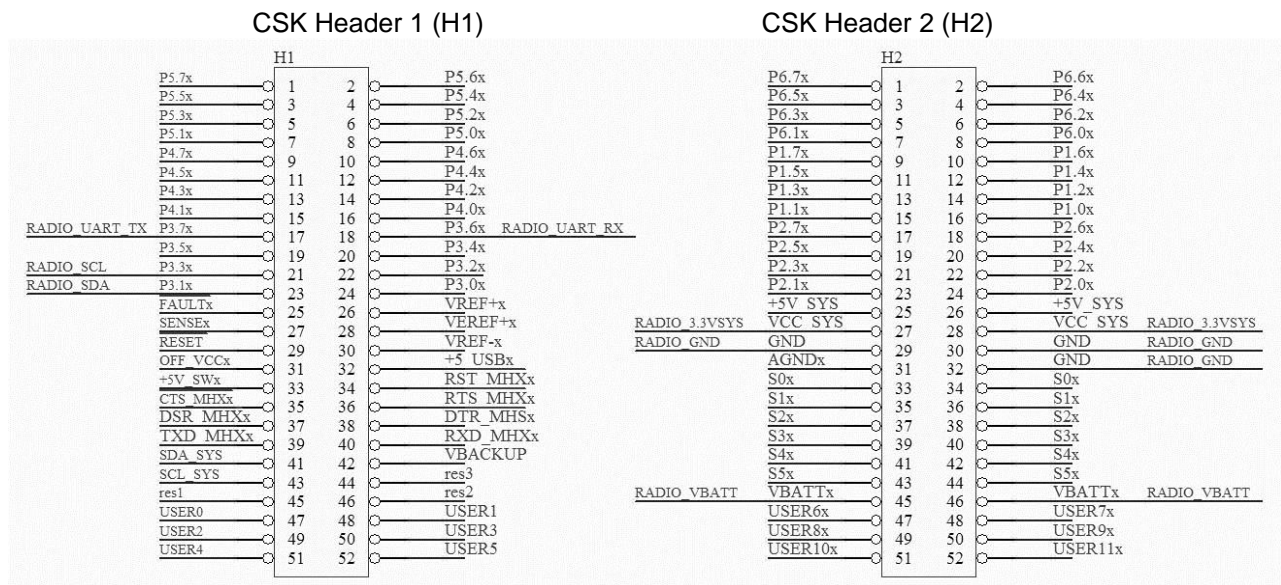

Figure 8 -- Cubesat Kit Radio Interface Pins

Table 1 -- Radio/CSK Pinout.

Radio Pin	CSK Pin #	CSK Pin Name	Typical Current Draw	Summary
RADIO_UART_RX	18	P3.6x	<2 mA	Radio UART interface Rx.
RADIO_UART_TX	17	P3.7x	<2 mA	Radio UART interface Tx.
RADIO_3.3VSYS	27 & 28	VCC_SYS	<75 mA	Radio 3.3V Voltage
RADIO_GND	29 & 30 & 32	GND	N/A	Radio Ground
RADIO_VBATT	45 & 46	VBATTx	<1.75 Amp	Radio Voltage for Power Amplifier

## Helium Radio Product Line

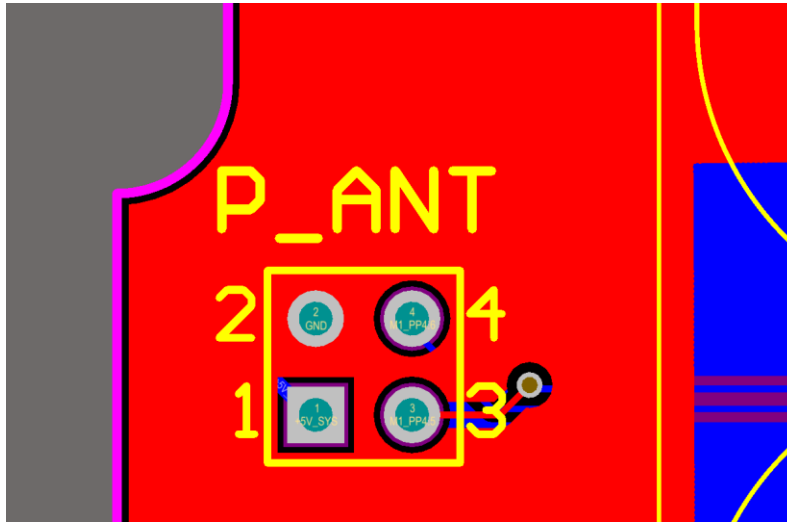

Figure 9 -- Radio Antenna Interface Pins

Table 2 -- Radio Antenna Pinout.

Radio Pin	Pin Name	Typical Current Draw	Summary
ANT_1	+5V_SYS	Bus Connection	Direct 5V Bus Connection
ANT_2	GND	N/A	System Ground
ANT_3	Polarity Switch	<40 mA	P4.5
ANT_4	TX/RX Switch	<40 mA	P4.6

### COMMUNICATING WITH THE HELIUM RADIO

Refer to AstroDev radio interface application note for detailed instructions.

### RADIO CONFIGURATION PROGRAM

Refer to radio configuration program application note for detailed instructions.

### DIMENSIONS AND FORM FACTOR

Compatibility with the CubeSat Kit: Stand alone full board in parallel with the FM430.



## Helium Radio Product Line

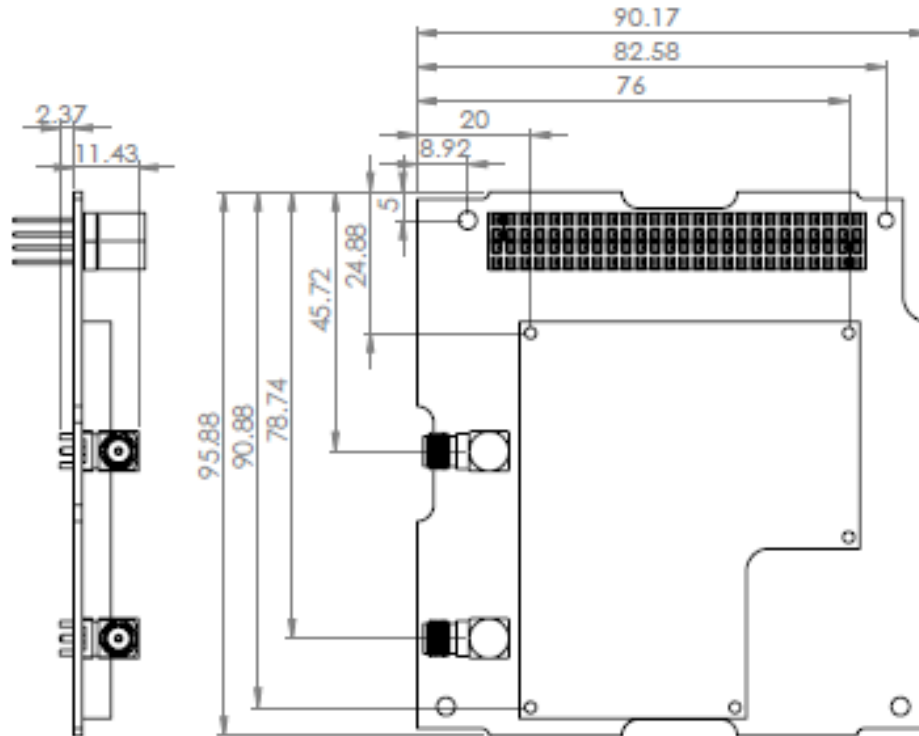

Figure 10 -- Radio Board Layout<sup>5</sup>

### PROTECTING AGAINST ELECTROSTATIC DISCHARGE

**CAUTION:** Disconnect the He-100 radio from power source before removing from operating environment.

Electrostatic discharge (ESD) events can harm electronic components inside the He-100. Under certain conditions, ESD may build up on your body or an object, such as an antenna, and then discharge into another object, such as the He-100. To prevent ESD damage, you should discharge static electricity from your body before you interact with any electronic components.

You can protect against ESD and discharge static electricity from your body by touching a metal grounded object (such as an unpainted metal surface such as your antistatic mat) before you interact with anything electronic devices. When connecting an antenna or power plug to the He-100, you should always ground both yourself and the CubeSat structure before connecting it.

You can also take the following steps to prevent damage from electrostatic discharge:

- When unpacking the He-100 from its shipping carton, do not remove the radio from the antistatic packing material until you are ready to install the component. Just before unwrapping the antistatic package, be sure to discharge static electricity from your body by wearing an antistatic wrist strap.
- When transporting the He-100, first place it in an antistatic container or packaging.

<sup>5</sup> All units are in mils.

## Helium Radio Product Line

- Handle the He-100 in a static-safe area. If possible, use antistatic floor pads and work bench pads.

### TRADEMARKS

In progress.

### DISCLAIMER

All information in this document is subject to change at anytime. Look for continued updates at:  
<http://www.astrodev.com/>

Helium radios are sold as test devices and require users to gain experimental license from the FCC for use in terrestrial and CSK satellite missions.

### NOTES